



**亞源科技股份有限公司**  
**ASIAN POWER DEVICES INC.,**

**SPECIFICATION FOR APPROVAL**

Model No.	DB-48A12
Model Name	DB-48A12-AAAB
Customer	Hewlett Packard
Customer P/N	TBD
Input Nameplate Range:	100-240V,50-60Hz
Input Operational Range:	90-264V,47-63Hz
Output :	12V/4A
Rev.	00

CUSTOMER AUTHORIZED SIGNATURE		

Please return to us one copy of "SPECIFICATION FOR APPROVAL" with you approved signature.

Approved By	Safety	EE	ME	Prepared by	Date
丁海平				肖皓妍	

HQ                      亞源科技股份有限公司  
 ADD : NO.5 LANE 83. LUNG-SOU ST, TAO-YUAN CITY, TAIWAN R.O.C.  
 TEL : 886-3-379-9078 FAX : 886-3-379-9263

Factory                亞源集團 亞榮源科技 ( 深圳 ) 有限公司 APD Group Yang Ming Industrial  
 ADD: No.10,Maliu Street, Heng-Gang Subdistrict, Long Gang District, Shen Zhen, P.R.China  
 Factory ID: F3  
 TEL : +86-755-28607978

                            亞源集團 亞瑞源科技 ( 深圳 ) 有限公司 APD Group DK Industrial  
 ADD:1-5/F,No.1,Fengwei Street, Da kang Community, Heng gang Subdistrict, Long gang District, Shen zhen, P.R.China  
 Factory ID: F4  
 TEL : +86-755-28316830

Made In China



## Change List

Rev.	Date	Changed contents	Why
00	2019-03-22	New	



# The Contents

<b>Item</b>	<b>Document Name</b>	<b>File Name</b>	<b>Sub-Page</b>	<b>Rev.</b>
1.	Electrical Specification	SXXXXX	4-7	00
2.	Mechanical Dimension	MXXXXX	8	00A
3.	LASER	L8030-XXXXX	9	00A



# Electrical Specification

**Model Name : DB-48A12-AAAB**

**Rev. 00**

## 1. SCOPE

This specification describes the physical, functional and electrical characteristics of the 48watts, single output +12V/4A, switching power supply.

## 2. INPUT CHARACTERISTICS

### 2.1. Input Voltage

Nameplate range : 100-240Vac  
Operational range : 90-264Vac

### 2.2. Input Frequency

Nameplate range : 50-60Hz  
Operational range : 47-63Hz

### 2.3. Input current

Input current should be lower than 1.5Arms/1Arms under full-load and 115Vac/230Vac input voltage conditions.

### 2.4. Inrush Current

Inrush current should not interrupt line fuse or cause damage to the power supply at cold start.

### 2.5. Power Consumption

Input power saving should be lower than 0.1Watts under No-load and 115/230Vac input voltage conditions. It would conform to “DoE 2016”

### 2.6. Efficiency

+12V output current 4A/3A/2A/1A respectively at 115Vac & 230Vac input voltage, the average efficiency should be greater than 87.77%, after burning in 0.5 hour at full load. It would conform to “DoE 2016”

## 3. OUTPUT CHARACTERISTICS

### 3.1. Output Characteristics

Output voltage, load current, voltage regulation and output noise of power supply should meet the specifications, which defined on the tables below:

Table 1 Electrical Characteristics overview

Item	Performance	Remarks
Output Voltage	12Vdc	
Output Range	± 5%	
Full Load	4.0A	
Min. Load	0.0A	
Max. Ripple Voltage	200mVp-p	@Ta=25°C (Note 1)
Hold Up Time	10mS Min	Full Load & 115Vac/60Hz Input @Ta=25°C (Note 2)
Turn on Time	5 S Max	Full Load & 115Vac/60Hz Input @Ta=25°C (Note 3)



# Electrical Specification

Model Name : DB-48A12-AAAB

Rev. 00

Output inrush current	>70A duration time < 600uS	100Vac/60Hz ~ 240Vac/50Hz @Ta=25°C
-----------------------	-------------------------------	------------------------------------

Note 1: Ripple voltage measurement is done with an oscilloscope set at a 20M Hz bandwidth with 0.1uF ceramic capacitor & parallel with 47uF low ESR electrolytic aluminum capacitor at full load.

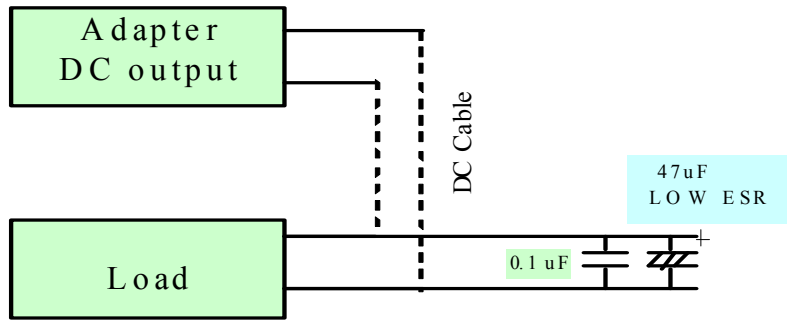

Note2: Turn off at input voltage 90° phase.

Note 3:

Turn On/Rise/Hold Up Time

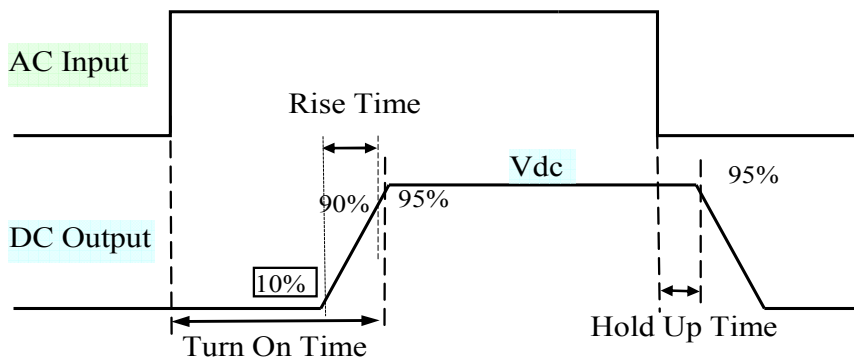

### 3.2. Output Protection :

**3.2.1. Short Circuit Protection:** No damage to this power supply when output is shorted to GND, Auto-recovery mode.

**3.2.2. Over Current Protection:** Power supply shall shutdown before output current reached 8A Max. @ 90Vac or 264Vac input. Auto-recovery mode.

**3.2.3. Over Voltage Protection:** The power supply shall shut down against over-voltage caused by fault conditions, the output voltage shall not exceed 20Vdc Max. Auto-recovery mode.

**3.2.4. Over Temperature Protection:** The case should be no deformation, no discoloration, no smoke and no fire under abnormal temperature.

## 4. ENVIRONMENT SECTION

**4.1. Operating Temperature :** 0°C to 45°C

**4.2. Operating Humidity :** 10% to 90%RH

**4.3. Storage Temperature :** -20°C to 80°C



# Electrical Specification

**Model Name : DB-48A12-AAAB**

**Rev. 00**

**4.4. Storage Humidity** : 5% to 95%RH

## **5. RELIABILITY**

**5.1. MTBF:** 300K hours minimum @ 25°C, full load & 90Vac/264Vac with SR-332.

### **5.2. Electrolytic Capacitors Lifetime:**

Calculated electrolytic capacitors lifetime should be more than 26280Hours, when tested at 3.5Aoutput; 90V and 264Vac input and 35°C ambient.

### **5.3. Vibration(non-operation)**

Waveform: Sinusoidal/

Acceleration: 2G

Frequency: 10 to 500Hz

Amplitude : 0.15mm

Sweep rate: 1 octave/min

Duration: 30 minutes on each axis X, Y and Z;

### **5.4. Drop:**

The test sample must be dropped from 100cm onto concrete floor for 6 times (1/face)

## **6. EMI STANDARDS :**

### **6.1. Conduction :**

**6.1.1.** It refers to CISPR PUB 22 or FCC part 15 Class B.

### **6.2. Radiation :**

**6.2.1.** It refers to CISPR PUB 22 or FCC part 15 Class B.

### **6.3. Harmonic Current :**

**6.3.1.** It refers to EN 61000-3-2

### **6.4. Flicker Voltage :**

**6.4.1.** It refers to EN 61000-3-3

## **7. EMS Standards :**

### **7.1. Electrostatic Discharge ESD :**

**7.1.1.** It refers to IEC 61000-4-2 criterion A.

**7.1.2.** Air Electrostatic Discharge: ±8KV

**7.1.3.** Contact Electrostatic Discharge: ±4KV

### **7.2. Radiated Immunity RS :**

**7.2.1.** It refers to IEC 61000-4-3

**7.2.2.** Radiated Susceptibility : 3V/m

### **7.3. Transient Burst (EFT) :**

**7.3.1.** It refers to IEC 61000-4-4

**7.3.2.** EFT Test : ±1KV

### **7.4. Surge :**

**7.4.1.** It refers to IEC 61000-4-5 criterion A

**7.4.2.** common mode Surge Immunity: ±4KV

**7.4.3.** differential mode Surge Immunity: ±2KV

### **7.5. Conducted Radio Frequency Disturbances Test CS :**

**7.5.1.** It refers to IEC 61000-4-6

**7.5.2.** Injected Current Susceptibility: 3Vrms

### **7.6. Power Frequency Magnetic Field Test :**

**7.6.1.** It refers to It refers to IEC 61000-4-8

### **7.7. Voltage Dips :**

**7.7.1.** It refers to IEC 61000-4-11



# Electrical Specification

Model Name : DB-48A12-AAAB

Rev. 00

## 8. SAFETY SECTION

### 8.1. Operating elevation

Power supply should be able to be used at an altitude of 5000 meters.

### 8.2. L.P.S:

Power supply should be conformed to L.P.S.

### 8.3. Leakage Current

Leakage current shall not exceed 100uA at 240 Vac/50Hz input.

### 8.4. Hi-Pot Test

**8.4.1. Primary to Secondary:** 10mA Max. @4242Vdc/3 Sec for in-process; 60 Sec for FQC (Final check).

### 8.5. Insulation

**8.5.1. Primary to Secondary** : 100M ohm Min. @500Vdc.

**8.6. Safety standards:** Meet IEC 60950-1 and IEC 62368-1.

## 9. MECHANICAL SECTION

**9.1. Dimension:** Refer to mechanical drawing for the details.

APD Proprietary Information / Document : No publicity , transmission to third party or competitor is allowed without APD Prior written consent.	Date: 2019-03-21	Approved by : 丁海平	Checked by : 吴昌水	Prepared by : 张毅
--	---------------------	----------------------	---------------------	---------------------

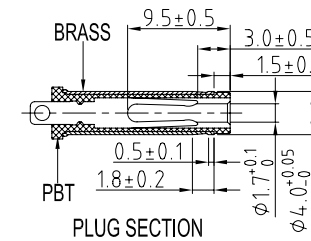
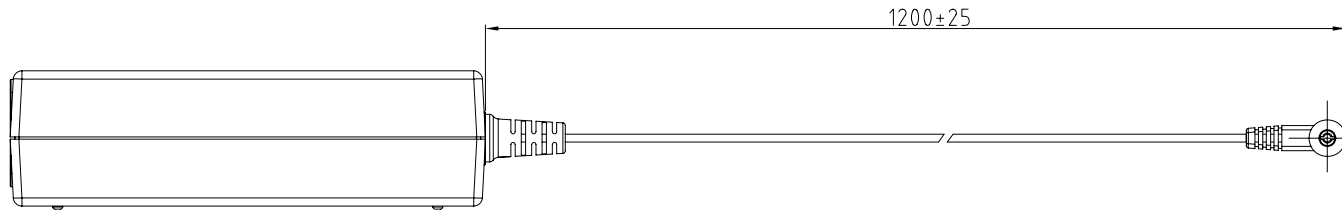
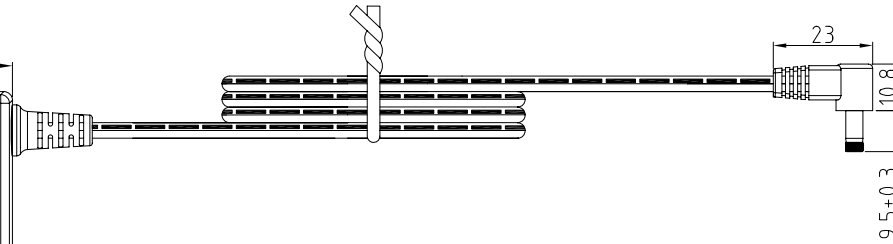
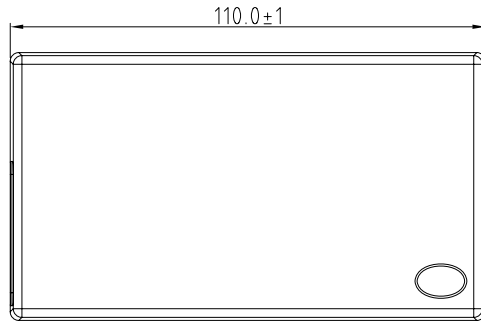
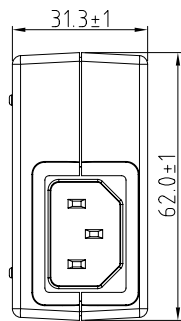

GENERAL NOTES	
1. COLOR	BLACK
2. AC RECEPTACLES	IEC-320+C14, 15A/250Vac
3. DC POWER CORD	UL 2468 #20AWG*2
4. DC POWER PLUG	φ4.0*φ1.7*L 9.5mm TUNING FORK TYPE (INNER 3 mm)
5. CABLE TIE	CABLE TIE (WITH-STEEL)
6. TOTAL WHEIGHT	ABOUT 210 g

		Approved By	王伟	Date	2019-01-15
		Checked By	赵操	Date	2019-01-15
		Designed By	傅光晨	Date	2019-01-15
Dimensions		Description: DB-48A12-AAAG MECHANICAL DRAWING			
Tolerances unless otherwise mentioned		Document No.		Rev.	Ord.
Size		M8030-XXXXX		00	A
Third Angle Projection		Sheet 1 of 1			

Rev.	Ord.	Revised History	Designed By/Date	Checked By/Date	Approved By/Date

No publicity, transmission is permitted and no delivery, disclosure is allowed to any third party without APD's prior written consent. Nothing contained herein is granted (whether by implication, estoppel, or otherwise) any of APD's trademark, patent, copyright, maskwork protection right or any other intellectual property right.



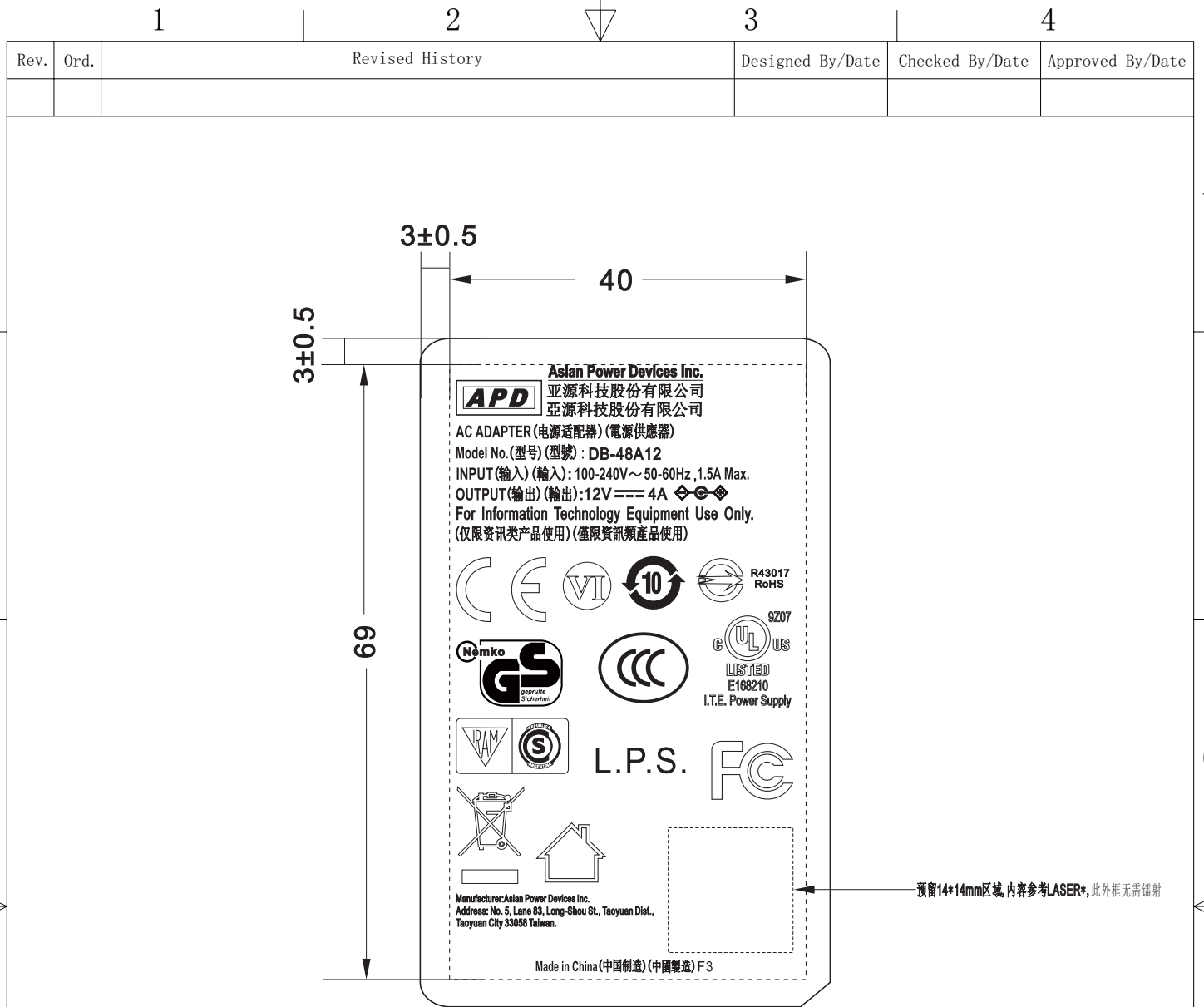

**Notes:**

- 虚线框仅示意LASER参考位置, 无需LASER.  
The referenced dotted box needn't to LASER.
- 虚线框内内容目视无明显倾斜.  
The contents of the dotted box are not visually skewed.
- 镭射内容需清晰可见.  
LASER contents must be clear.

预留14\*14mm区域, 内容参考LASER\*, 此外框无需镭射



Approved By	王伟	Date	2019-01-15
Checked By	张园	Date	2019-01-15
Designed By	傅光晨	Date	2019-01-15

Dimensions								0<X≤6	6<X≤30	30<X≤80	80<X≤180	180<X≤320	320<X≤600	>600	Description: <b>LASER</b>			
Tolerances unless otherwise mentioned	A	±0.05	±0.1	±0.15	±0.2	±0.25	±0.35	±0.5	Part No. _____ Type No. _____ Rev. _____ Sup No. _____ L8030-XXXXX 00 / A									
	V	±0.1	±0.15	±0.2	±0.25	±0.4	±0.5	±0.65										
	C	±0.2	±0.3	±0.4	±0.6	±0.8	±1	±2										
	D	±0.5	±1	±1.5	±2.2	±3.5	±5	±6.5										
Holes: ±0.1								Angles: ±0.5°										
Size	A4	Unit	mm	Scale	Free	Third Angle Projection				Sheet 1 Of 1								

No publicity, transmission is permitted and no delivery, disclosure is allowed to any third party without APD's prior written consent. Nothing contained herein is granted (whether by implication, estoppel, or otherwise) any of APD's trademark, patent, copyright, maskwork protection right or any other intellectual property right.